

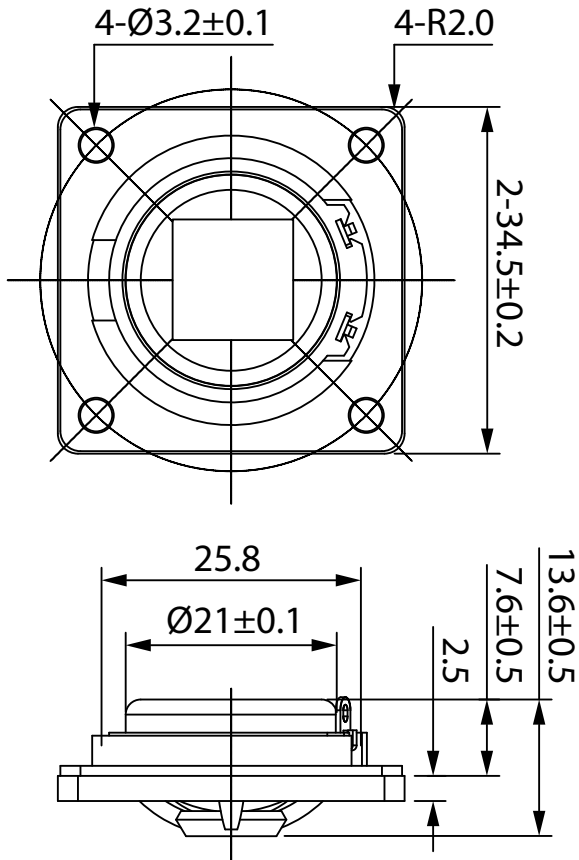

# 1" Silk Dome Tweeter 10W 4 ohm

CE35-4



## PARAMETERS

Impedance	4 ohms
Re	3.3 ohms
Le	0.01 mH @ 10 kHz
Fs	3,300 Hz
Qms	N/A
Qes	N/A
Qts	N/A
Mms	N/A
Cms	N/A
Sd	N/A
Vd	N/A
BL	N/A
Vas	N/A
Xmax	N/A
VC Diameter	16 mm
SPL	90 dB @ 2.83V/1m
RMS Power Handling (AES 426B)	10 watts
Usable Frequency Range (Hz)	3,500 - 17,000 Hz

## IMPEDANCE/PHASE

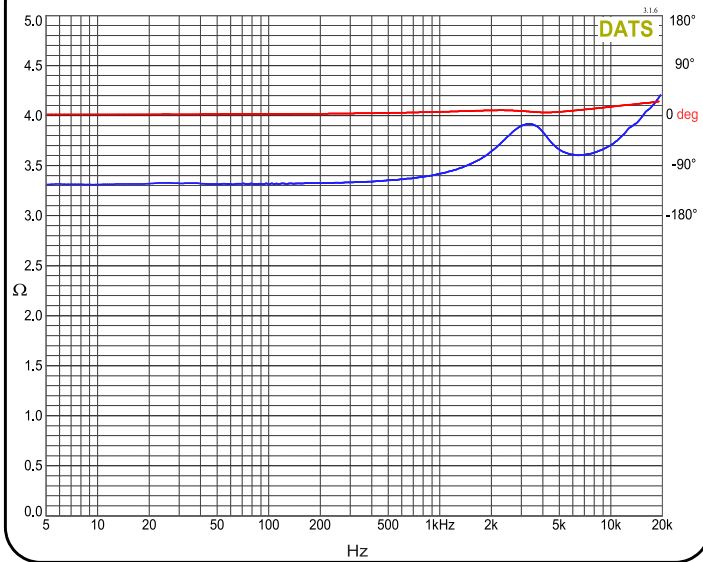

## FEATURES

- High economic value
- Delivers crisp, clear audio, ensuring an immersive listening experience
- High-quality audio solutions without breaking the bank, ideal for budget-conscious projects
- Suitable for commercial installations, DIY projects, art exhibits, and more

## FREQUENCY RESPONSE

